

Norbo Sofa





Norbo

Welcome style and sophistication into your home with our N-Series sofa range. Characterised by a low profile, distinctive arm shapes and elegant standing legs, the N-Series sofa combines minimalist design and style to create a truly sleek sofa that will complement the theme of your living area.

Norbo presents a simple yet attractive sofa with its use of finer styling details. With a slimmer, block-shaped arm and subtle stitching detail Norbo achieves a more classic shape and graceful profile. Generously padded cushioning throughout the back and seat cushions gives Norbo a welcoming effect, just waiting to be experienced.

Warranty - See warranty policy for more details.

	10 years on molded foam cushions and steel frames
	5 years on mechanisms
	2 years on leather and fabric covers
YEAR WARRANTY	 DESIGNED IN NORWAY

The IMG Promise

Our products are subjected to the highest Norwegian quality standards. Our comprehensive warranty policy is our promise to you that your furniture has been built to last.

Multiple Configuration Options

With our Norbo sofa, you can make it your own with a wide range of seating configurations available to suit your living area. From 1, 2, 2.5 or 3-seater to open-end sofas and corner seats, along with a range of customizable arm and leg options to suit your taste.



1 Seat

2 Seat

2.5 Seat

3 Seat Duo

3 Seat

Long Seat + 2 Seat

Open End Module + Corner + 3 Seat

3 Seat + Corner + 2 Seat

Pall

* Please note: These images illustrate the configuration only, sofa arms differ.

Features

1. Higher Grade Foam

Created through cold-cure foam technology, this ensures ergonomically correct seating posture and support which lasts.

2. Steel Interior Springs

Steel springs located throughout the back and seat provide optimum support whilst cradling the body.

3. Solid Construction

A steel and hardwood frame provides durability and strength.

4. Leg Options

Choose from an aluminium leg either polished or unpolished, or choose one of our new leg options: a tube-shaped leg available in a brushed and black finish, or a straight wooden leg available in 9 colour options. Customise your sofa further with 2 leg positions: either underneath the armrests or under the seat for a more alternative look.

5. New Seat Depth Option

Our new 3cm cushion depth allows for improved comfort and added ergonomic support, encouraging correct leg posture while seated.

Leg Options and Positions



1. Steel Brushed Tube Leg

2. Steel Black Tube Leg

3. Wood Straight Leg (9 colours)

4. Aluminum Black Leg

5. Aluminum Polished Leg



Leg under the arm



Leg under the seat



Aluminum leg under the arm

Headrest Option



Norbo Technical Specifications

1 Seat

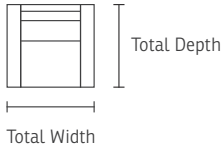

2 Seat

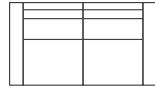

2.5 Seat

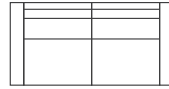

3 Seat

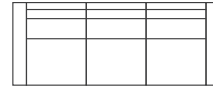

3 Seat Duo

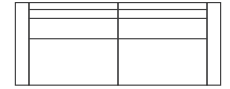

Long Seat + 2s

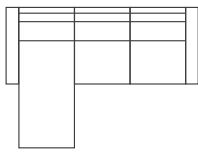

3s + Long Seat

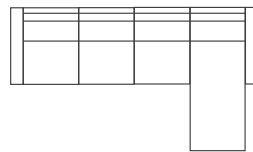

Long Seat + 2s +
Corner + 2s

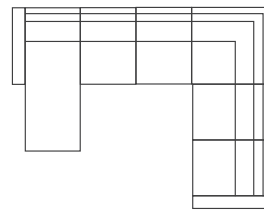

2s + Corner + 2.5s

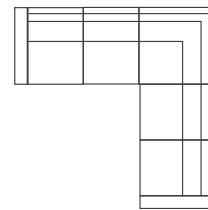

3s + Corner + 2s

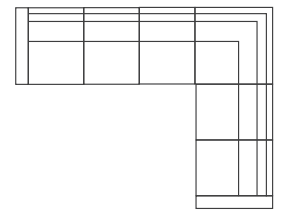

Open End Module +
Corner + 3s Duo

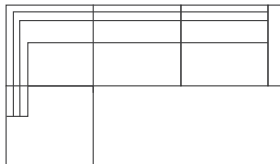

3s Duo + Corner +
Open End Module

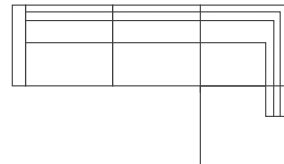

Open End Module +
Corner + 3s

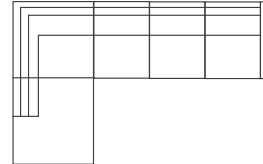

3s + Corner +
Open End Module

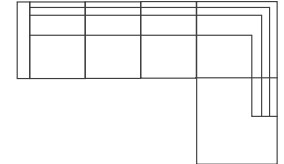

Measurements*

Norbo	Total Width	Total Depth	Arm Height	Total Height	Seat Height	Seat Depth
1 Seat	84 cm / 33 in	82-85 cm / 32.2-33.4 in	62 cm / 24.4 in	84 cm / 33 in	44 cm / 17.3 in	50-53 cm / 19.6-20.8 in
2 Seat	144 cm / 56.6 in	82-85 cm / 32.2-33.4 in	62 cm / 24.4 in	84 cm / 33 in	44 cm / 17.3 in	50-53 cm / 19.6-20.8 in
2.5 Seat	174 cm / 68.5 in	82-85 cm / 32.2-33.4 in	62 cm / 24.4 in	84 cm / 33 in	44 cm / 17.3 in	50-53 cm / 19.6-20.8 in
3 Seat	204 cm / 80.3 in	82-85 cm / 32.2-33.4 in	62 cm / 24.4 in	84 cm / 33 in	44 cm / 17.3 in	50-53 cm / 19.6-20.8 in
3 Seat Duo	204 cm / 80.3 in	82-85 cm / 32.2-33.4 in	62 cm / 24.4 in	84 cm / 33 in	44 cm / 17.3 in	50-53 cm / 19.6-20.8 in
Long Seat + 2s	204 cm / 80.3 in	148 cm / 58.2 in	62 cm / 24.4 in	84 cm / 33 in	44 cm / 17.3 in	50-53 cm / 19.6-20.8 in
Long Seat + 2s + Corner + 2s	276 cm / 108.6 in	216 cm / 85 in	62 cm / 24.4 in	84 cm / 33 in	44 cm / 17.3 in	50-53 cm / 19.6-20.8 in
2s + Corner + 2.5s	216 cm / 85 in	246 cm / 96.8 in	62 cm / 24.4 in	84 cm / 33 in	44 cm / 17.3 in	50-53 cm / 19.6-20.8 in
3s + Long Seat	264 cm / 103.9 in	148 cm / 58.2 in	62 cm / 24.4 in	84 cm / 33 in	44 cm / 17.3 in	50-53 cm / 19.6-20.8 in
3s + Corner + 2s	276 cm / 108.6 in	216 cm / 85 in	62 cm / 24.4 in	84 cm / 33 in	44 cm / 17.3 in	50-53 cm / 19.6-20.8 in
Open End Module + Corner + 3s Duo	276 cm / 108.6 in	194 cm / 76.3 in	62 cm / 24.4 in	84 cm / 33 in	44 cm / 17.3 in	50-53 cm / 19.6-20.8 in
3s Duo + Corner + Open End Module	276 cm / 108.6 in	194 cm / 76.3 in	62 cm / 24.4 in	84 cm / 33 in	44 cm / 17.3 in	50-53 cm / 19.6-20.8 in
Open End Module + Corner + 3s	276 cm / 108.6 in	194 cm / 76.3 in	62 cm / 24.4 in	84 cm / 33 in	44 cm / 17.3 in	50-53 cm / 19.6-20.8 in
3s + Corner + Open End Module	276 cm / 108.6 in	194 cm / 76.3 in	62 cm / 24.4 in	84 cm / 33 in	44 cm / 17.3 in	50-53 cm / 19.6-20.8 in

* The dimensions are approximate and may vary with +/-2cm

Norbo Module Options

Modules

1 Seat
no arm



2 Seat
no arm

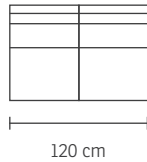

2.5 Seat
no arm

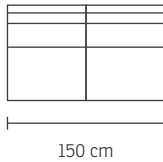

3 Seat
no arm

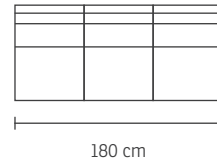

3 Seat Duo
no arm

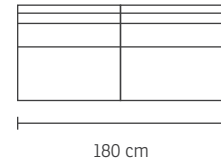

82 - 85 cm

Corner

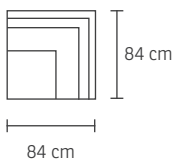

Long seat

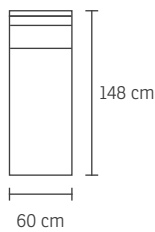

Pall

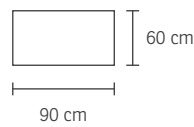

Headrest

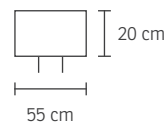

Arm

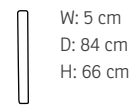

End module

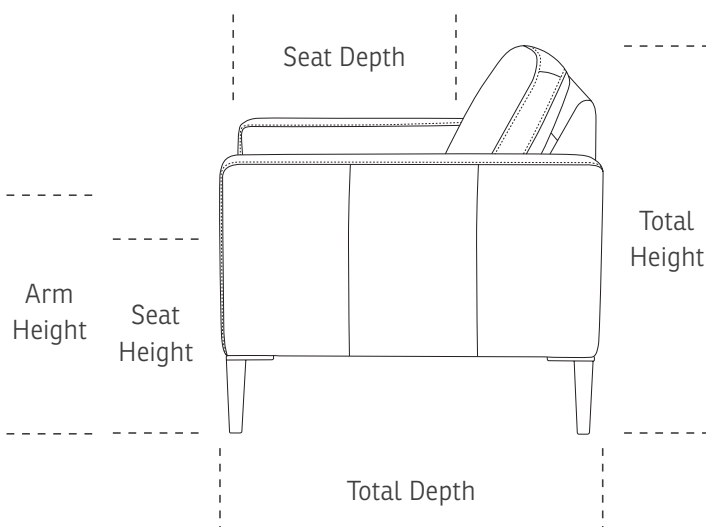
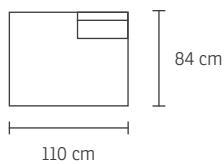
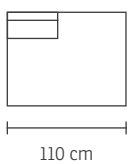

Cushion Size Options:

Choose between two seat depth options

A. Cushion 50cm (Standard)

B. Cushion 53cm