

# Norbo Sofa





## Norbo

Welcome style and sophistication into your home with our N-Series sofa range. Characterised by a low profile, distinctive arm shapes and elegant standing legs, the N-Series sofa combines minimalist design and style to create a truly sleek sofa that will complement the theme of your living area.

Norbo presents a simple yet attractive sofa with its use of finer styling details. With a slimmer, block-shaped arm and subtle stitching detail Norbo achieves a more classic shape and graceful profile. Generously padded cushioning throughout the back and seat cushions gives Norbo a welcoming effect, just waiting to be experienced.

**Warranty** - See warranty policy for more details.

	10 years on molded foam cushions and steel frames
	5 years on mechanisms
	2 years on leather and fabric covers
<b>YEAR WARRANTY</b>	 <b>DESIGNED IN NORWAY</b>

## The IMG Promise

Our products are subjected to the highest Norwegian quality standards. Our comprehensive warranty policy is our promise to you that your furniture has been built to last.

# WOHLERS

HOMEWARES FURNITURE CAFE

Mount Barker | Richmond | Tanunda | Victor Harbor

## Multiple Configuration Options

With our Norbo sofa, you can make it your own with a wide range of seating configurations available to suit your living area. From 1, 2, 2.5 or 3-seater to open-end sofas and corner seats, along with a range of customizable arm and leg options to suit your taste.



\* Please note: These images illustrate the configuration only, sofa arms differ.

## Features

### 1. Higher Grade Foam

Created through cold-cure foam technology, this ensures ergonomically correct seating posture and support which lasts.

### 2. Steel Interior Springs

Steel springs located throughout the back and seat provide optimum support whilst cradling the body.

### 3. Solid Construction

A steel and hardwood frame provides durability and strength.

### 4. Leg Options

Choose from an aluminium leg either polished or unpolished, or choose one of our new leg options: a tube-shaped leg available in a brushed and black finish, or a straight wooden leg available in 9 colour options. Customise your sofa further with 2 leg positions: either underneath the armrests or under the seat for a more alternative look.

### 5. New Seat Depth Option

Our new 3cm cushion depth allows for improved comfort and added ergonomic support, encouraging correct leg posture while seated.

## Leg Options and Positions



Leg under the arm



Leg under the seat



Aluminum leg under the arm

## Headrest Option



# Norbo Technical Specifications

1 Seat

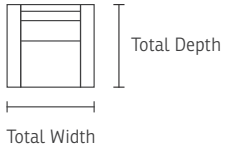

2 Seat

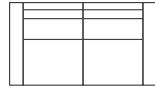

2.5 Seat

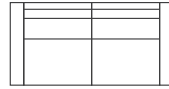

3 Seat

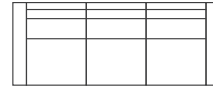

3 Seat Duo

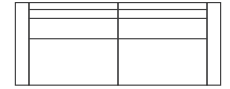

Long Seat + 2s

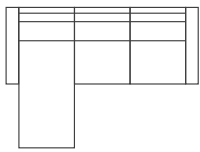

3s + Long Seat

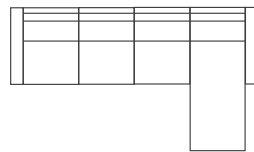

Long Seat + 2s +  
Corner + 2s

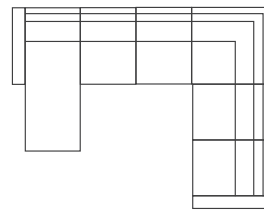

2s + Corner + 2.5s

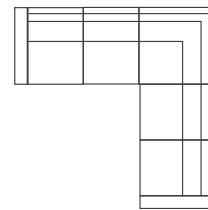

3s + Corner + 2s

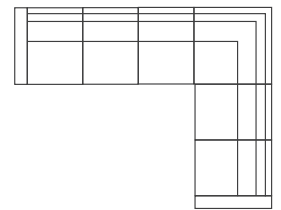

Open End Module +  
Corner + 3s Duo

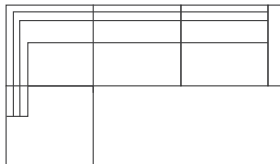

3s Duo + Corner +  
Open End Module

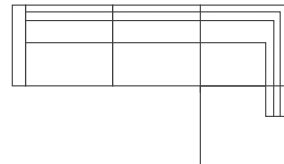

Open End Module +  
Corner + 3s

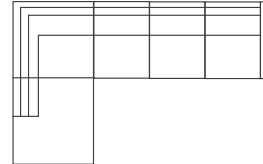

3s + Corner +  
Open End Module

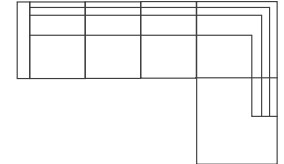

## Measurements\*

Norbo	Total Width	Total Depth	Arm Height	Total Height	Seat Height	Seat Depth
1 Seat	84 cm / 33 in	82-85 cm / 32.2-33.4 in	62 cm / 24.4 in	84 cm / 33 in	44 cm / 17.3 in	50-53 cm / 19.6-20.8 in
2 Seat	144 cm / 56.6 in	82-85 cm / 32.2-33.4 in	62 cm / 24.4 in	84 cm / 33 in	44 cm / 17.3 in	50-53 cm / 19.6-20.8 in
2.5 Seat	174 cm / 68.5 in	82-85 cm / 32.2-33.4 in	62 cm / 24.4 in	84 cm / 33 in	44 cm / 17.3 in	50-53 cm / 19.6-20.8 in
3 Seat	204 cm / 80.3 in	82-85 cm / 32.2-33.4 in	62 cm / 24.4 in	84 cm / 33 in	44 cm / 17.3 in	50-53 cm / 19.6-20.8 in
3 Seat Duo	204 cm / 80.3 in	82-85 cm / 32.2-33.4 in	62 cm / 24.4 in	84 cm / 33 in	44 cm / 17.3 in	50-53 cm / 19.6-20.8 in
Long Seat + 2s	204 cm / 80.3 in	148 cm / 58.2 in	62 cm / 24.4 in	84 cm / 33 in	44 cm / 17.3 in	50-53 cm / 19.6-20.8 in
Long Seat + 2s + Corner + 2s	276 cm / 108.6 in	216 cm / 85 in	62 cm / 24.4 in	84 cm / 33 in	44 cm / 17.3 in	50-53 cm / 19.6-20.8 in
2s + Corner + 2.5s	216 cm / 85 in	246 cm / 96.8 in	62 cm / 24.4 in	84 cm / 33 in	44 cm / 17.3 in	50-53 cm / 19.6-20.8 in
3s + Long Seat	264 cm / 103.9	148 cm / 58.2 in	62 cm / 24.4 in	84 cm / 33 in	44 cm / 17.3 in	50-53 cm / 19.6-20.8 in
3s + Corner + 2s	276 cm / 108.6 in	216 cm / 85 in	62 cm / 24.4 in	84 cm / 33 in	44 cm / 17.3 in	50-53 cm / 19.6-20.8 in
Open End Module + Corner + 3s Duo	276 cm / 108.6 in	194 cm / 76.3 in	62 cm / 24.4 in	84 cm / 33 in	44 cm / 17.3 in	50-53 cm / 19.6-20.8 in
3s Duo + Corner + Open End Module	276 cm / 108.6 in	194 cm / 76.3 in	62 cm / 24.4 in	84 cm / 33 in	44 cm / 17.3 in	50-53 cm / 19.6-20.8 in
Open End Module + Corner + 3s	276 cm / 108.6 in	194 cm / 76.3 in	62 cm / 24.4 in	84 cm / 33 in	44 cm / 17.3 in	50-53 cm / 19.6-20.8 in
3s + Corner + Open End Module	276 cm / 108.6 in	194 cm / 76.3 in	62 cm / 24.4 in	84 cm / 33 in	44 cm / 17.3 in	50-53 cm / 19.6-20.8 in

\* The dimensions are approximate and may vary with +/-2cm

# Norbo Module Options

## Modules

1 Seat  
no arm



60 cm

2 Seat  
no arm

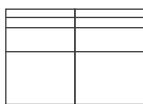

120 cm

2.5 Seat  
no arm

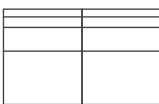

150 cm

3 Seat  
no arm

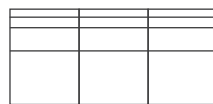

180 cm

3 Seat Duo  
no arm

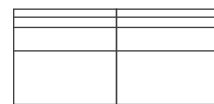

180 cm

82 - 85 cm

Corner



84 cm

Long seat

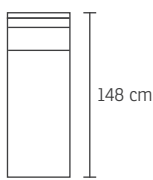

148 cm

60 cm

Pall

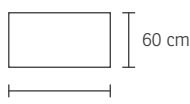

60 cm

90 cm

Headrest

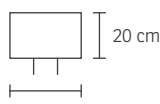

20 cm

55 cm

Arm



W: 12 cm  
D: 84 cm  
H: 66 cm

End module

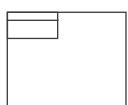

110 cm

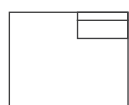

110 cm

84 cm

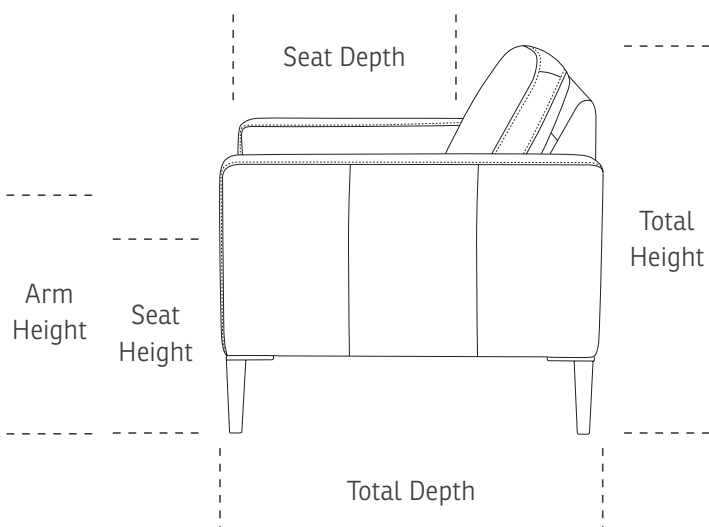

## Cushion Size Options:

Choose between two seat depth options

A. Cushion 50cm (Standard)

B. Cushion 53cm